

5.0x5.0mm, Pure Green LED
Surface Mount PLCC-6 LED
Indicator Technical Data Sheet

Part No.: YBH-R5050PGC-3G

Features:

- ◇ PLCC-6 package.
- ◇ White package.
- ◇ High reliability package with silicone encapsulation.
- ◇ Ideal for backlight and light pipe application.
- ◇ Suitable for reflow and wave solder processes.
- ◇ The product itself will remain within RoHS compliant version.

Descriptions:

- ◇ The R5050 SMT LEDs is packaged in the industry standard PLCC-6 package. These SMT LEDs have high reliability performance and are designed to work under a wide range of environmental conditions. This high reliability feature makes them ideally suited to be used as interior signs application conditions.
- ◇ To facilitate easy pick & place assembly, the LEDs are packed in EIA-compliant tape and reel. Every reel will be shipped in single intensity and color bin.
- ◇ The wide viewing angle at 120° makes these LEDs ideally suited for panel, push button, industrial equipment, and home appliances. The flat top emitting surface makes it easy for these LEDs to mate with light pipes. With the built-in reflector pushing up the intensity of the light output, these LEDs are also suitable to be used as LED pixels in interior electronic signs.

Applications:

- ◇ Non-automotive use.
- ◇ General Signage backlighting.
- ◇ Amusement machine backlighting.
- ◇ Industrial lighting.
- ◇ Light strips.

Package Dimension:

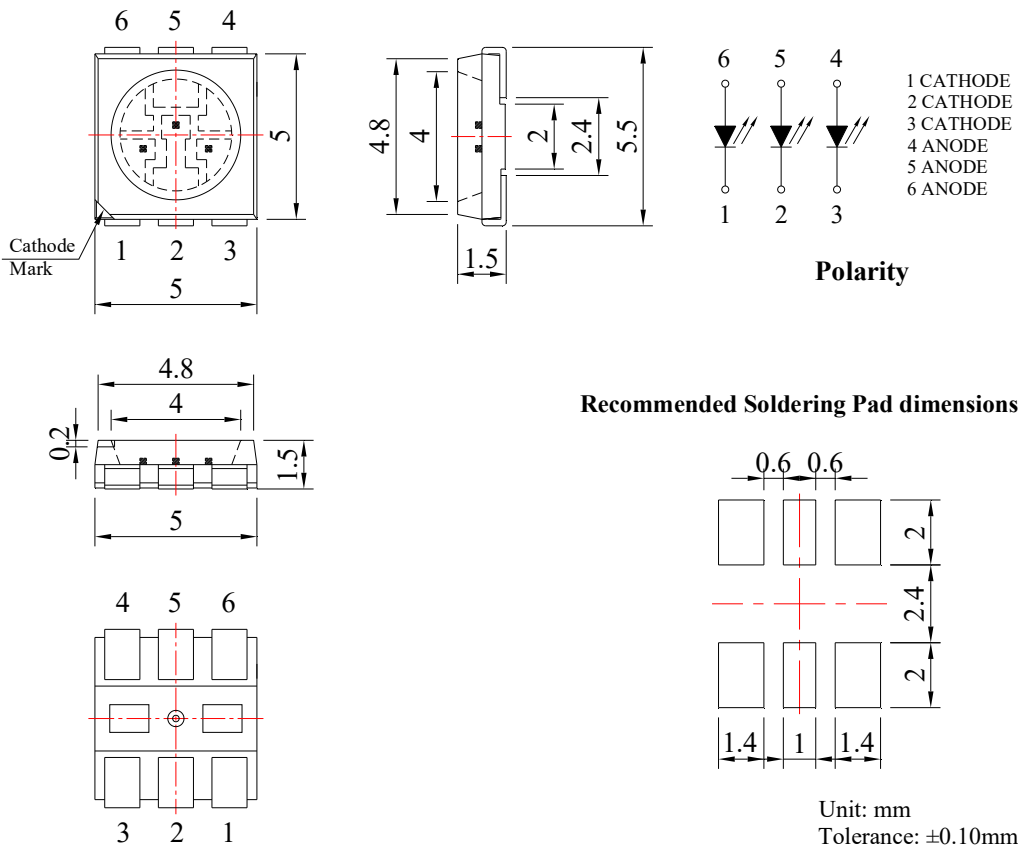

Part No.	Chip Material	Lens Color	Source Color
YBH-R5050PGC-3G	InGaN	Water Clear	Pure Green

Notes:

1. All dimensions are in millimeters (inches).
2. Tolerance is ± 0.10 mm (.004") unless otherwise specified.

Absolute Maximum Ratings at Ta=25°C

Parameters	Symbol	Max	Unit
Power Dissipation (Per Chip)	PD	90*3	W
Peak Forward Current (Per Chip) (1/10 Duty Cycle, 0.1ms Pulse Width)	IFP	100*3	mA
Continuous Forward Current (Per Chip)	IF	25*3	mA
Reverse Voltage (Per Chip)	VR	5	V
Electrostatic Discharge (HBM)	ESD	1000	V
Operating Temperature Range	Topr	-40°C to +80°C	
Storage Temperature Range	Tstg	-40°C to +85°C	
Soldering Temperature	Tsld	260°C for 5 Seconds	

Electrical Optical Characteristics at Ta=25°C

Parameters	Symbol	Min.	Typ.	Max.	Unit	Test Condition
Luminous Intensity ^(a)	IV	3500	5500	---	mcd	IF=20*3 =60 mA
Luminous Flux ^(a)	Φv	7.5	10.0	---	lm	IF=20*3 =60 mA
Viewing Angle ^(b)	2θ1/2	---	120	---	Deg	IF=20*3 =60 mA
Peak Emission Wavelength	λp	---	520	---	nm	IF=20*3 =60 mA
Dominant Wavelength ^(c)	λd	---	525	---	nm	IF=20*3 =60 mA
Spectral Line Half-Width	Δλ	---	35	---	nm	IF=20*3 =60 mA
Forward Voltage ^(c)	VF	2.70	3.00	3.20	V	IF=20*3 =60 mA
Reverse Current	IR	---	---	10	μA	VR=5V

Notes:

- a. Luminous flux measurement tolerance: ±10%.
- b. Color coordinates measurement tolerance: ±0.015
- c. Forward voltage measurement tolerance: ±0.1V

Typical Electrical / Optical Characteristics Curves
(25°C Ambient Temperature Unless Otherwise Noted)

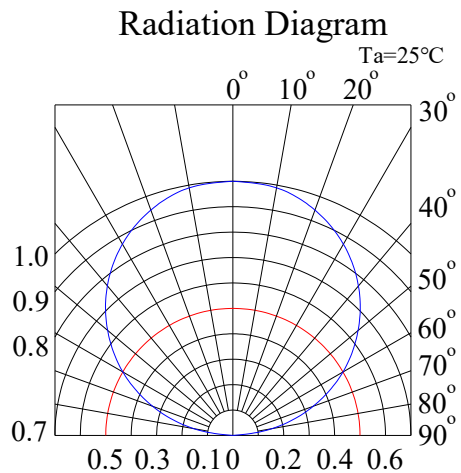
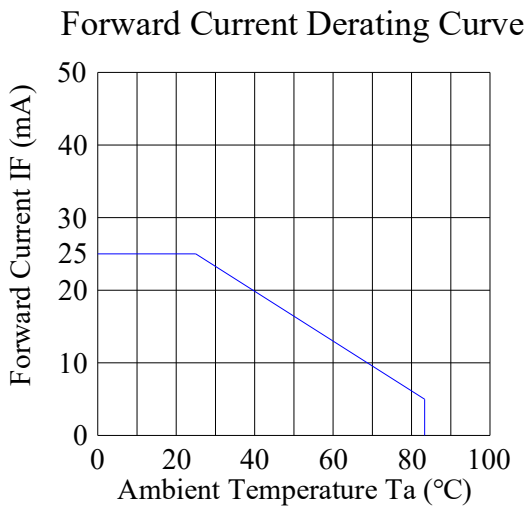
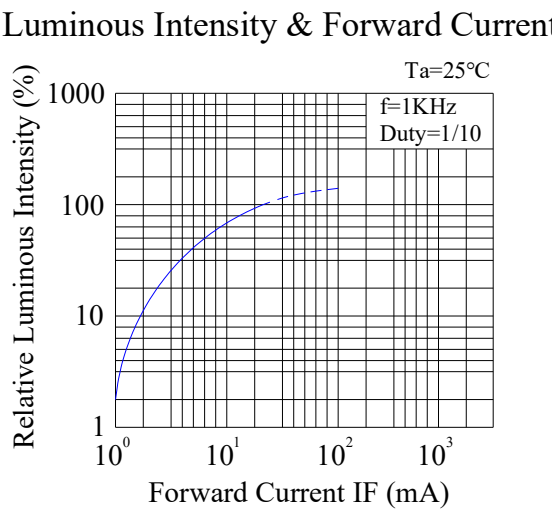
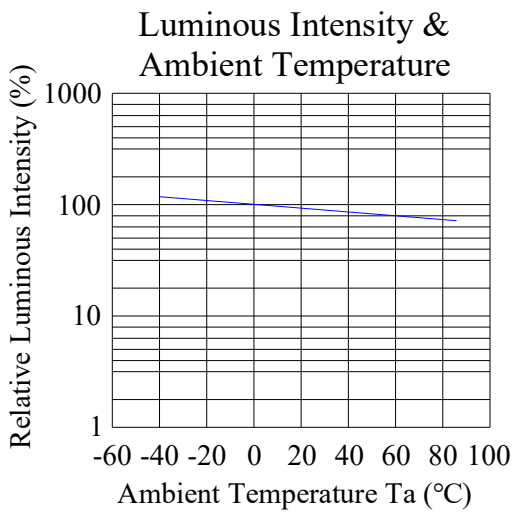
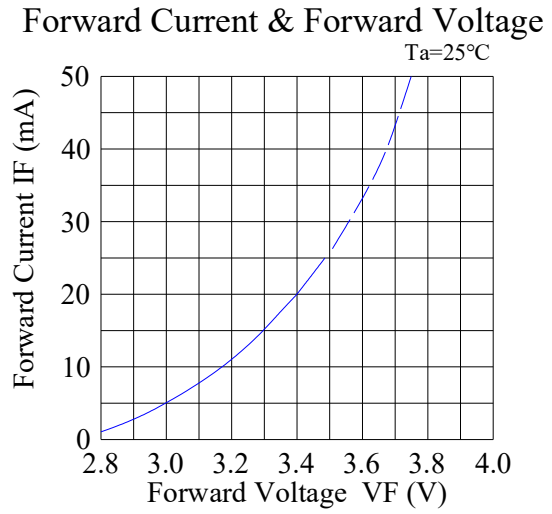
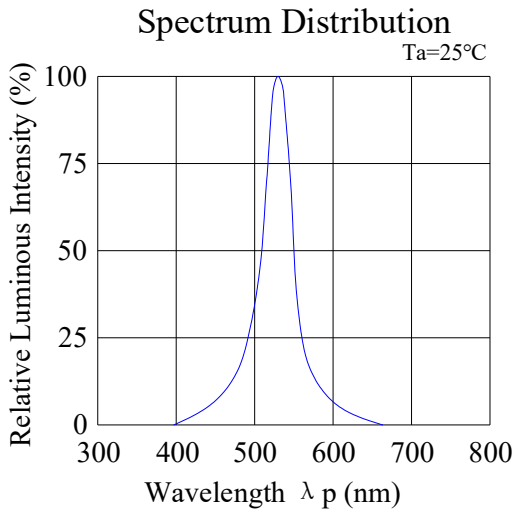

Reel Dimensions:

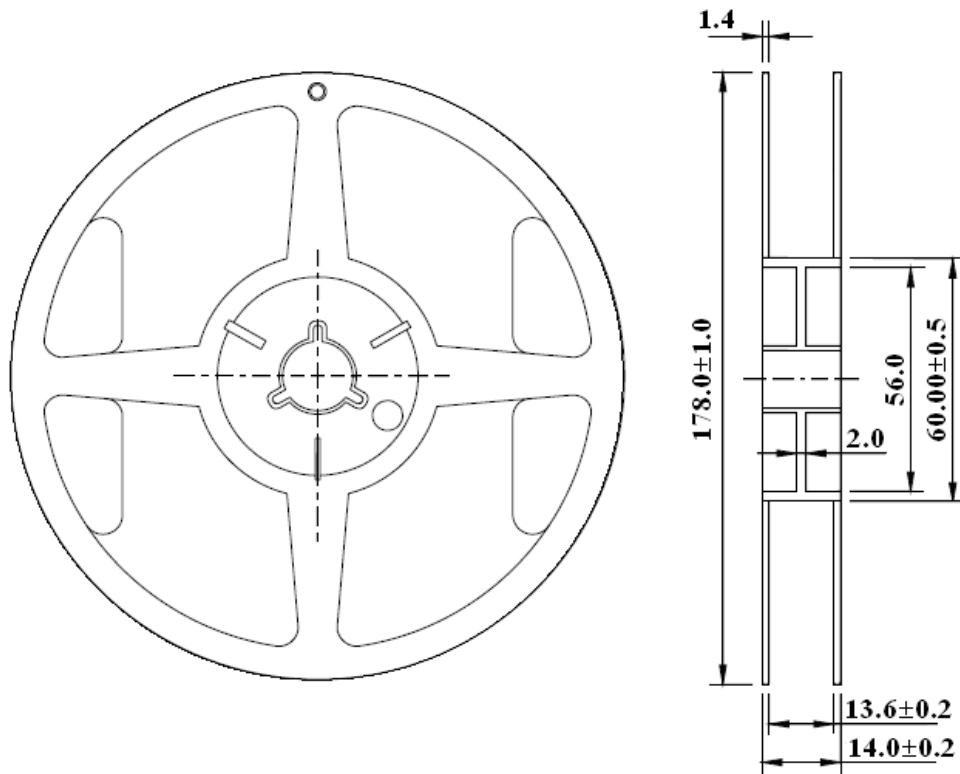

Carrier Tape Dimensions:

Loaded quantity 1000PCS Per reel.

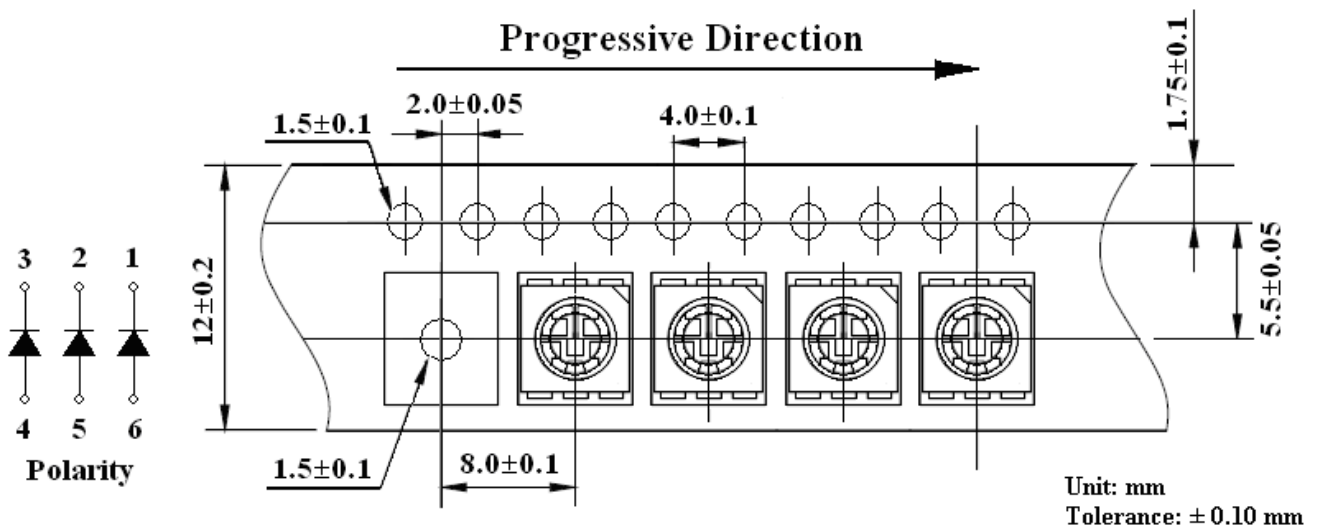

CAUTIONS

1. Handling Precautions:

- 1.1. Handle the component along the side surfaces by using forceps or appropriate tools.
- 1.2. Do not directly touch or handle the silicone lens surface. It may damage the internal circuitry.
- 1.3. Do not stack together assembled PCBs containing exposed LEDs. Impact may scratch the silicone lens or damage the internal circuitry.

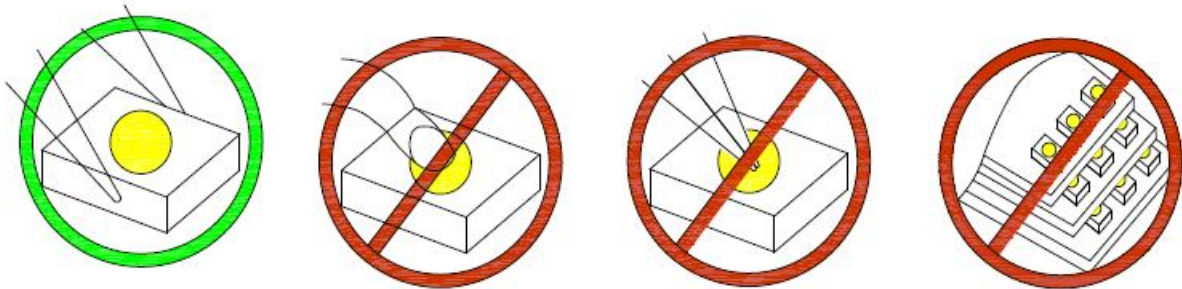

Compare to epoxy encapsulant that is hard and brittle, silicone is softer and flexible. Although its characteristic significantly reduces thermal stress, it is more susceptible to damage by external mechanical force. As a result, special handling precautions need to be observed during assembly using silicone encapsulated LED products. Failure to comply might lead to damage and premature failure of the LED.

2. Storage

- 2.1. Do not open moisture proof bag before the products are ready to use.
- 2.2. Before opening the package, the LEDs should be kept at 30°C or less and 60%RH or less.
- 2.3. The LEDs should be used within a year.
- 2.4. After opening the package, the LEDs should be kept at 30°C or less and 60%RH or less.
- 2.5. The LEDs should be used within 24 hours after opening the package.
- 2.6. If the moisture adsorbent material has fabled away or the LEDs have exceeded the storage time, baking treatment should be performed using the following conditions. Baking treatment: 65±5°C for 24 hours.

3. Soldering Condition

3.1. Pb-free solder temperature profile

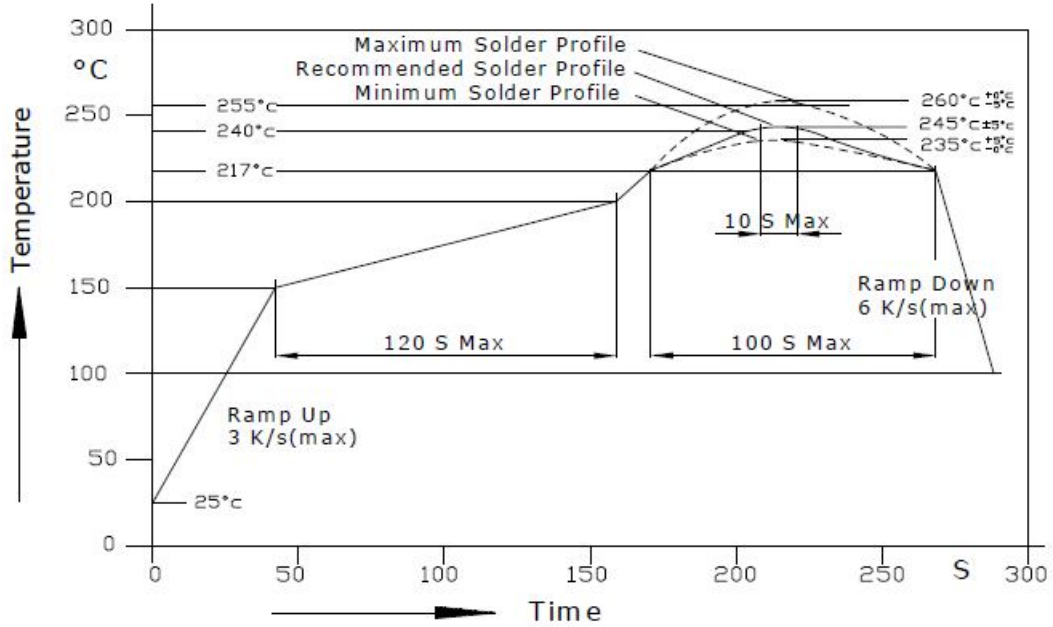

3.2. Reflow soldering should not be done more than two times.

3.3. When soldering, do not put stress on the LEDs during heating.

3.4. After soldering, do not warp the circuit board.

3.5. Recommended soldering conditions:

Reflow soldering		Soldering iron	
Pre-heat	150~200°C	Temperature	300°C Max.
Pre-heat time	120 sec. Max.	Soldering time	3 sec. Max.
Peak temperature	250°C Max.		(one time only)
Soldering time	10 sec. Max.(Max. two times)		

3.6. Because different board designs use different number and types of devices, solder pastes, reflow ovens, and circuit boards, no single temperature profile works for all possible combinations. However, you can successfully mount your packages to the PCB by following the proper guidelines and PCB-specific characterization.

4. Drive Method

4.1. An LED is a current-operated device. In order to ensure intensity uniformity on multiple LEDs connected in parallel in an application, it is recommended that a current limiting resistor be incorporated in the drive circuit, in series with each LED as shown in Circuit A below.

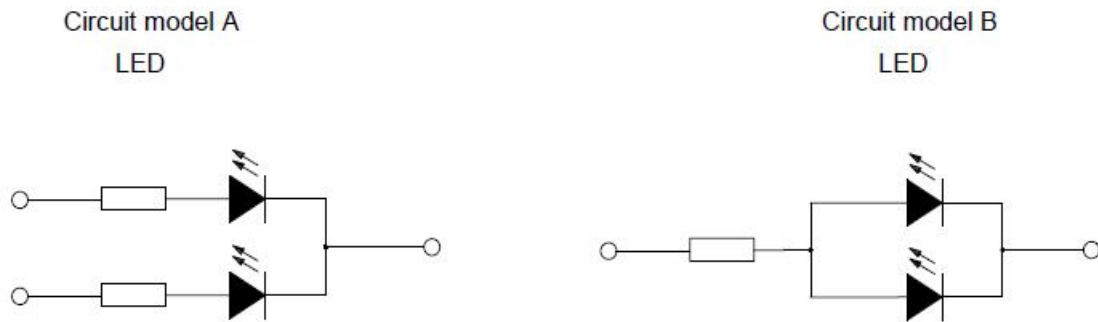

- a. Recommended circuit.
- b. The brightness of each LED might appear different due to the differences in the I-V characteristics of those LEDs.

5. ESD (Electrostatic Discharge):

Static Electricity or power surge will damage the LED. Suggestions to prevent ESD damage:

1. Use of a conductive wrist band or anti-electrostatic glove when handling these LEDs.
2. All devices, equipment, and machinery must be properly grounded.
3. Work tables, storage racks, etc. should be properly grounded.
4. Use ion blower to neutralize the static charge which might have built up on surface of the LED' s plastic lens as a result of friction between LEDs during storage and handling.

ESD-damaged LEDs will exhibit abnormal characteristics such as high reverse leakage current, low forward voltage, or "no lightup" at low currents. To verify for ESD damage, check for "lightup" and V_f of the suspect LEDs at low currents. The V_f of "good" LEDs should be $>2.0V@0.1mA$ for InGaN product and $>1.4V@0.1mA$ for AlInGaP product.