

F

E

D

C

B

A

RoHS Compliant

SYMBOL

REVISION

APPROVAL

DATE

## SPECIFICATIONS

- ELECTRICAL CHARACTERISTICS:
  - 1-1.RATING: DC 12V 2A
  - 1-2.CONTACT RESISTANCE: 20mΩ MAX(INITIAL)
  - 1-3.DIELECTRIC WITHSTANDING VOLTAGE: 500V AC FOR ONE MINUTE
  - 1-4.INSULATION RESISTANCE: 100MΩ MIN,MEASURED BY 500V DC
- LIFE TEST:MECHANICAL LIFE TEST 10,000 CYCLES.
- PACKING:BAG(1000PCS/BAG)

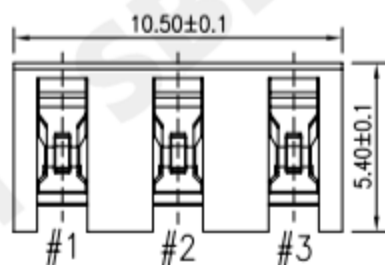
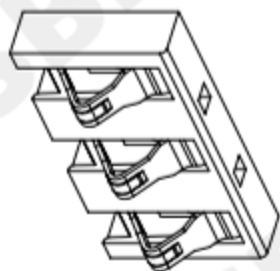

SCHEMATIC

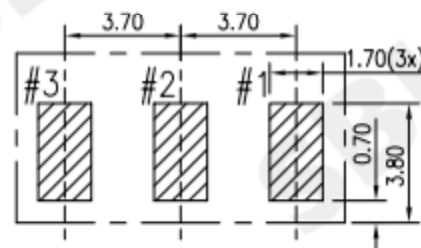
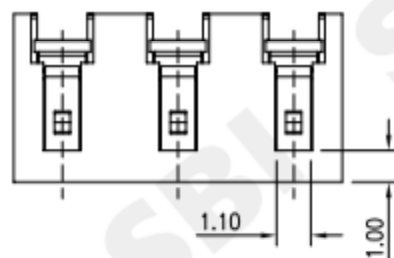
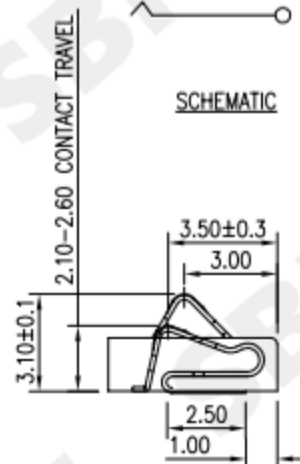
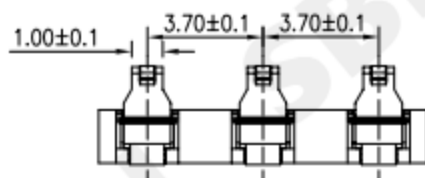
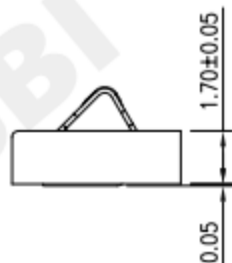
RECOMMENDED P.C.B LAYOUT  
TOP VIEW (TOLERANCE:±0.05)

No.	DESCRIPTION	MATERIAL	PLATING
1	CONTACT TERMINAL	BeCu	Au PLATED
2	HOUSING	LCP	BLACK

SMART BILLION INDUSTRIAL LIMITED

COPYRIGHT RESERVED,PLEASE DO NOT COPY.

PART NAME

CONNECTOR

DRAWING

Z.L.Liang

DWG.No.

PART NO.

CL-025S-3P

CHECK

G.C.Chen

REV.

A0



UNIT :

TOLERANCE UNLESS OTHERWISE SPECIFIED

X.X ± 0.3  
X.XX ± 0.2  
X.XXX ± 0.1

ANGLE

APPROVAL

G.C.Chen

DATE

2018-Aug-03

SCALE

1:1

PAGE

1 OF 1

F

E

D

C

B

A