

RoHS
Compliant

SYMBOL	REVISION	APPROVAL	DATE

SPECIFICATIONS

- ELECTRICAL CHARACTERISTICS:
 - 1-1.RATING: DC 12V 1A
 - 1-2.CONTACT RESISTANCE: 30mΩ MAX(INITIAL)
 - 1-3.DIELECTRIC WITHSTANDING VOL TAGE: 500V AC FOR ONE MINUTE
 - 1-4.INSULATION RESISTANCE: 100MΩ MIN,MEASURED BY 500V DC
- MECHANICAL CHARACTERISTICS:
 - 2-1.INSERTION FORCE: 0.5KG-2.2Kg
 - 2-2.WITHDRAWAL FORCE: 0.5KG-2.0Kg
- LIFE TEST: 5,000 CYCLES MIN
- PACKING: TAPE & REEL
- FOR HAND SOLDERING LEAD FREE PROCESS
- PRINTED DATE CODE "YY MM DD" ON TOP OF CONNECTOR

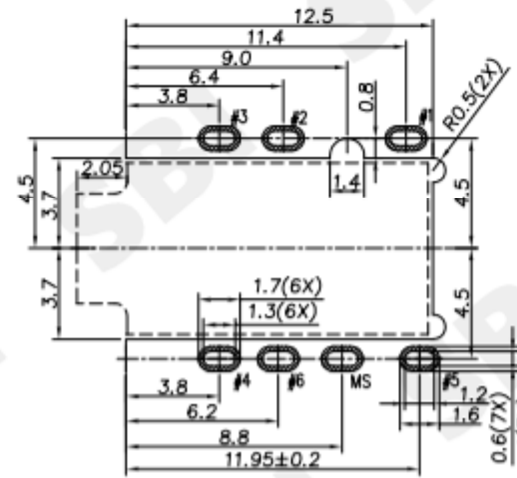
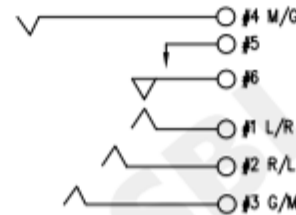
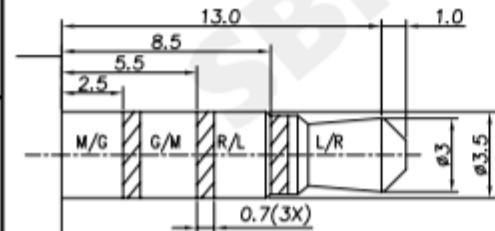
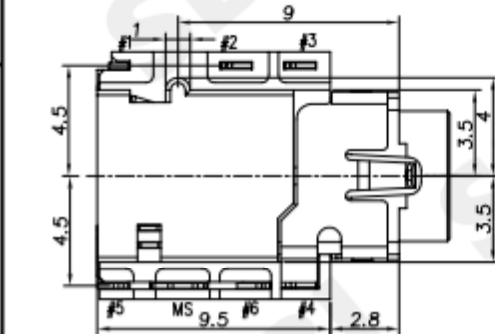
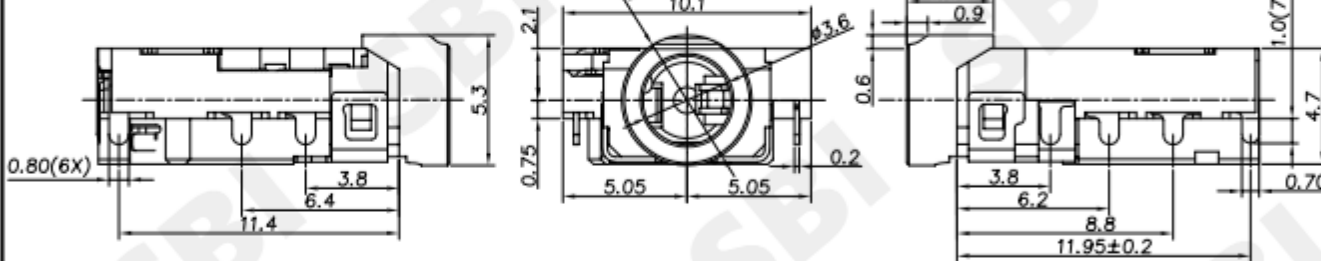
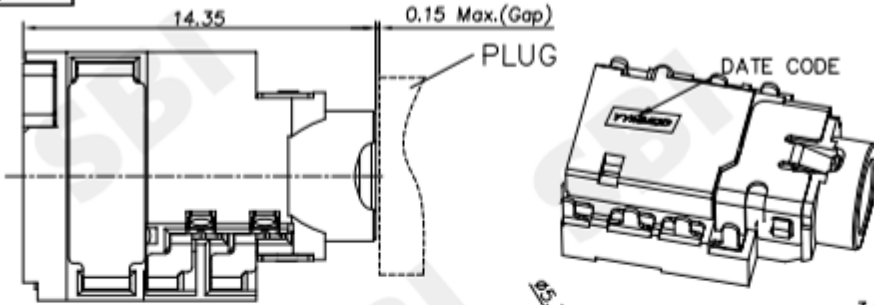
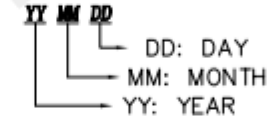

No.	DESCRIPTION	MATERIAL	QTY.	PLATING
9	HOUSING	PPA UL 94V0	1	BLACK
8	INSULATOR	PPA UL 94V0	1	BLACK
7	TERMINAL MS	C2680	1	Ni PLATED
6	TERMINAL #6	C5210	1	1u" Au PLATED
5	TERMINAL #5	C5210	1	1u" Au PLATED
4	TERMINAL #4	C5210	1	1u" Au PLATED
3	TERMINAL #3	C5210	1	1u" Au PLATED
2	TERMINAL #2	C5210	1	1u" Au PLATED
1	TERMINAL #1	C5210	1	1u" Au PLATED

SMART BILLION INDUSTRIAL LIMITED

COPYRIGHT RESERVED,PLEASE DO NOT COPY.

PART NAME	STEREO JACK (4 POLES)	DRAWING	Z.L.Liang	DWG.No.	
PART NO.	ST-3570	CHECK	G.C.Chen	REV.	A0
UNIT : mm	TOLERANCE UNLESS OTHERWISE SPECIFIED	ANGLE	G.C.Chen	DATE	2017/06/23
	UP TO 5 ±0.2	0±3'	SCALE	1:1	PAGE 1 OF 1
	ABOVE 5 ~30 ±0.3				
	ABOVE 30 ±0.5				
	ANGLE ±3'				