

RoHS  
Compliant

SYMBOL	REV.	REVISION	APPROVAL	DATE

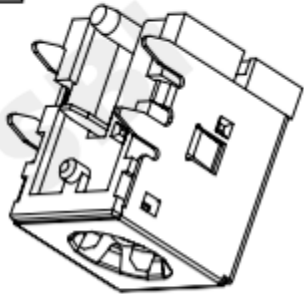

PART NO.	DIA.
DS-129-20-1.2	20
DS-129-25-1.2	25

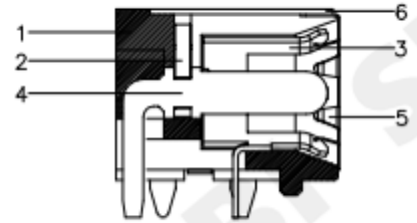

**SPECIFICATIONS**

- ELECTRICAL CHARACTERISTICS:
  - RATING: DC 8A 24V
  - CONTACT RESISTANCE: 30mΩ MAX(INITIAL)
  - DIELECTRIC WITHSTANDING VOLTAGE: 500V AC FOR ONE MINUTE
  - INSULATION RESISTANCE: 100MΩ MIN, MEASURED BY 500V DC
- MECHANICAL PERFORMANCE
  - OPERATING FORCE : 0.5-3.0kgf
- LIFE TEST
  - ELECTRONICS LIFE TEST 5,000 CYCLES.
- MEASURING CONDITION:
  - TEMPERATURE: FROM 5°C TO 35°C.
  - RELATIVE HUMIDITY: FROM 45% TO 85%RH .
- ENVIRONMENTAL SPECIFICATIONS:
  - HUMIDITY TEST: HUMIDITY 90% TO 95% TEMPERATURE 40 ± 2°C FOR 96 HOURS.
  - HEAT TEST: TEMPERATURE 80 ± 2°C (HUMIDITY BELOW 50%)
  - COLD TEST: TEMPERATURE -40 ± 2°C FOR 96 HOURS.

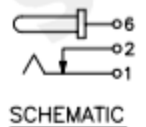
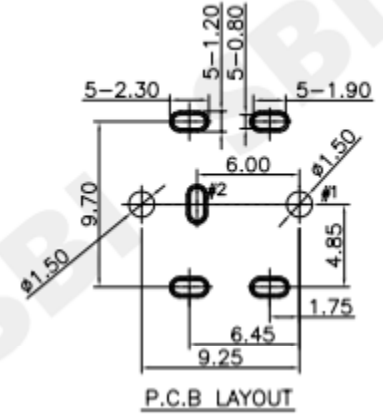
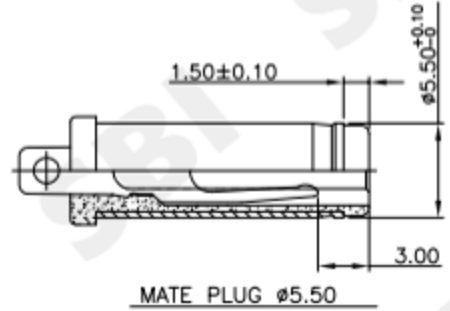
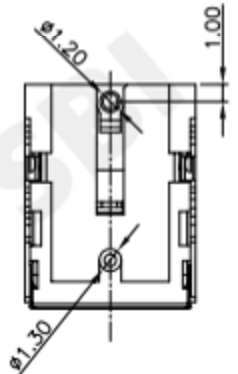
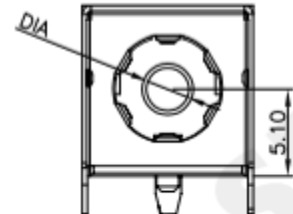
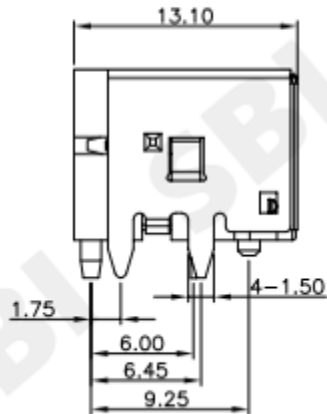
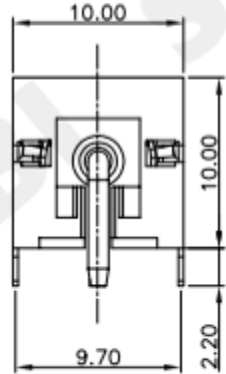

No.	DESCRIPTION	MATERIAL	QTY.	PLATING
6	FRAME	C2680	1	NI PLATED
5	COVER	SUS	1	NI PLATED
4	PIN TEMRINAL(D)	C2680	1	Au PLATED
3	SPRING CONTACT	C5210	1	Ag PLATED
2	COVER	PA10T 94V0	1	BLACK
1	HOUSING	PA10T 94V0	1	BLACK

**SMART BILLION INDUSTRIAL LIMITED**

COPYRIGHT RESERVED, PLEASE DO NOT COPY.

PART NAME		DC POWER JACK		DRAWING	Z.L.Liang	DWG.No.
PART NO.		DS-129-25-1.2		CHECK	G.C.Chen	REV.
UNIT :	TOLERANCE UNLESS OTHERWISE SPECIFIED	X.X ± 0.3	X.XX ± 0.2	ANGLE	G.C.Chen	DATE
mm		X.XXX ± 0.1		±2'		2021/01/26
				SCALE	1:1	PAGE
						1 OF 1